

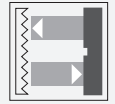

Retroreflective sensor GLV18-55/115/120



- Efficient Line in a short M18 plastic housing for standard applications
- Very high detection range
- 4 LEDs indicator for 360° visibility
- Optimized potentiometer design for a clear control button layout in the application
- Version with front optical face
- DC voltage version

Retroreflective sensor with polarization filter, M18 threaded housing design, plastic housing, front optical face, 4 m detection range, red light, light/dark on, DC version, 2 PNP outputs, fixed cable



Function

The GLV/GLK18 series sensors help improve the efficiency of machines and systems. The design of the M18 plastic housing, the connection technology, and sensor properties are highly standardized. Concentrating on the key sensor requirements has produced a robust and reliable product series for DC and AC/DC voltage systems without any over-engineering. The mounting set included in the scope of delivery and the optimized potentiometer design ensure fast assembly and easy configuration.

Dimensions

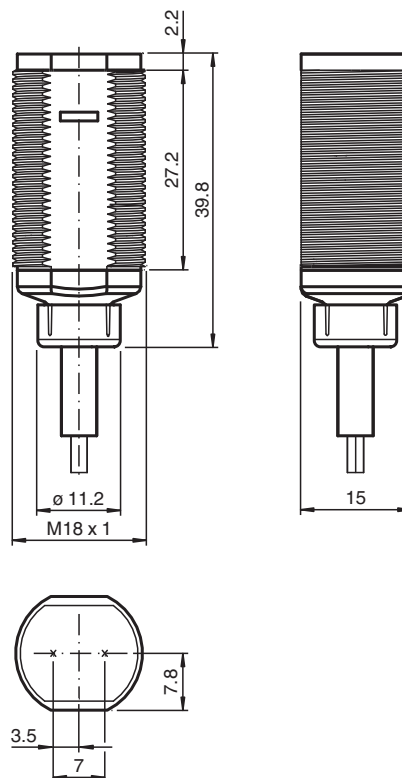

Technical Data

General specifications		
Effective detection range		0 ... 4 m
Reflector distance		0.05 ... 4 m
Threshold detection range		5.5 m
Reference target		reflector C110-2
Light source		LED
Light type		modulated visible red light , 640 nm
Polarization filter		yes
Diameter of the light spot		approx. 200 mm at 5.5 m
Angle of divergence		approx. 2 °
Optical face		frontal
Ambient light limit		30000 Lux
Functional safety related parameters		
MTTF _d		920 a
Mission Time (T _M)		20 a
Diagnostic Coverage (DC)		0 %
Indicators/operating means		
Operation indicator		LED green, statically lit Power on
Function indicator		LED yellow: lights up when receiving the light beam ; flashes when falling short of the stability control; OFF when light beam is interrupted
Electrical specifications		
Operating voltage	U _B	10 ... 30 V DC
No-load supply current	I ₀	< 20 mA
Output		
Switching type		light/dark on
Signal output		2 PNP, complementary, short-circuit protected, open collectors
Switching voltage		max. 30 V DC
Switching current		max. 100 mA
Voltage drop	U _d	≤ 1.5 V DC
Switching frequency	f	500 Hz
Response time		≤ 1 ms
Conformity		
Product standard		EN 60947-5-2
Approvals and certificates		
Protection class		II, Rated insulation voltage ≤ 50 V AC with pollution degree 1-2 according to IEC 60664-1
UL approval		cULus Listed, Class 2 Power Source
CCC approval		CCC approval / marking not required for products rated ≤36 V
Ambient conditions		
Ambient temperature		-25 ... 60 °C (-13 ... 140 °F)
Storage temperature		-40 ... 70 °C (-40 ... 158 °F)
Mechanical specifications		
Degree of protection		IP67
Connection		2 m fixed cable
Material		
Housing		PC
Optical face		PMMA
Cable		PVC
Mass		approx. 75 g

Connection Assignment

Option:

/120

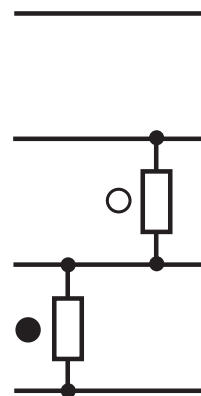
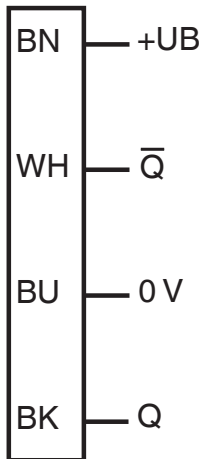

○ = Light on
● = Dark on

Assembly

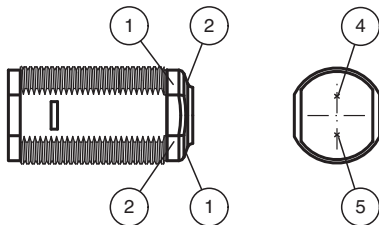

1	Operating display	green
2	Signal display	yellow
4	Emitter	
5	Receiver	

Characteristic Curve

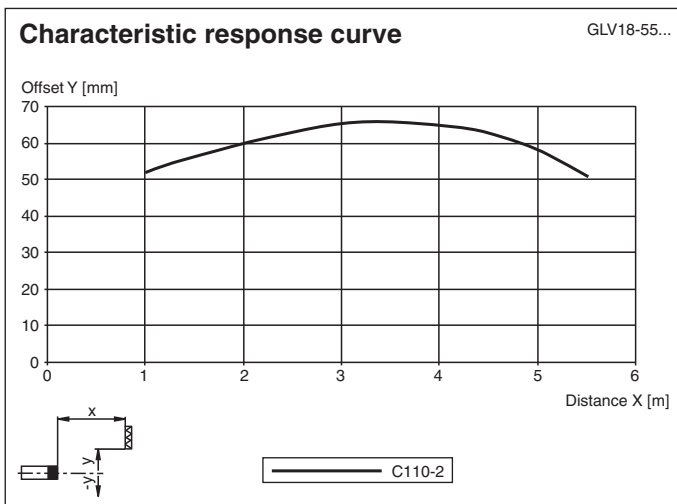

Release date: 2020-12-03 Date of issue: 2020-12-03 Filename: 188562_eng.pdf

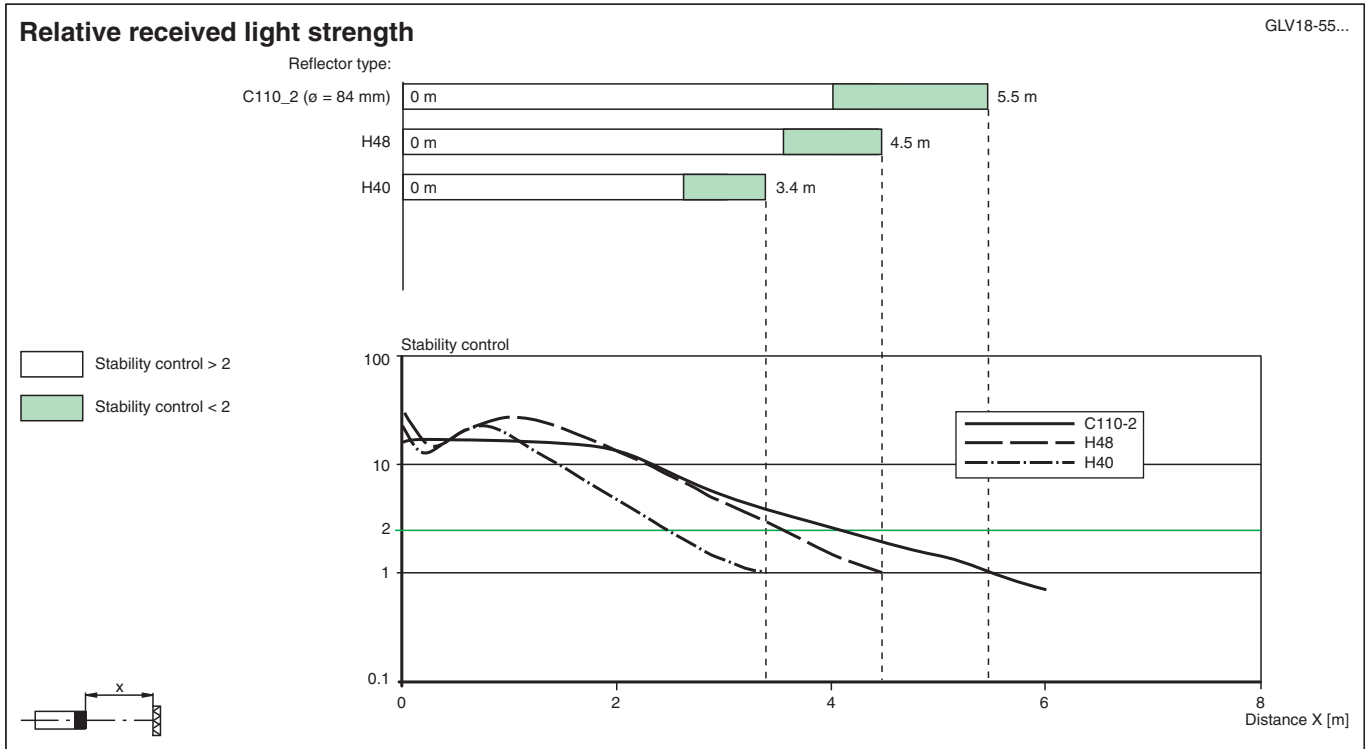

Application



Accessories

	CPZ18B03	Mounting Bracket with swivel nut
	BF 18	Mounting flange, 18 mm
	BF 18-F	Plastic mounting adapter, 18 mm
	BF 5-30	Universal mounting bracket for cylindrical sensors with a diameter of 5 ... 30 mm

Release date: 2020-12-03 Date of issue: 2020-12-03 Filename: 188562_eng.pdf

Accessories

Other suitable accessories can be found at www.pepperl-fuchs.com

Application

Packaging industry:

- Presence checks, track loading, completeness checks, stack height control

Material handling

- Presence checks, target sensor, profile checks, trigger sensor

Automatic doors, gates and access systems, elevator:

- Secure detection for automatic door and gate systems
- Monitoring function in turnstiles
- Closing edge monitoring in elevators